

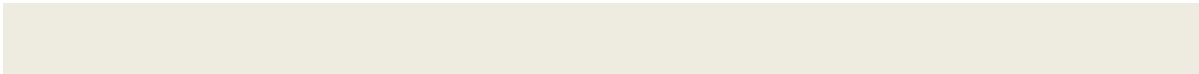

DG H LDI G C ., L D.



C . D D D A

**DG H LDI G C ., L D.**

**L D**

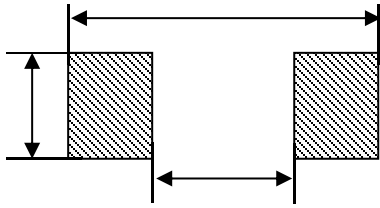

- 
- 

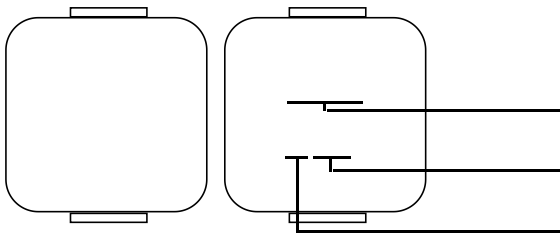

.	I		DC ( )		C	H
	$\mu$				I (A .)	I (A .)

:

:

( ),

( )

I

. DC C

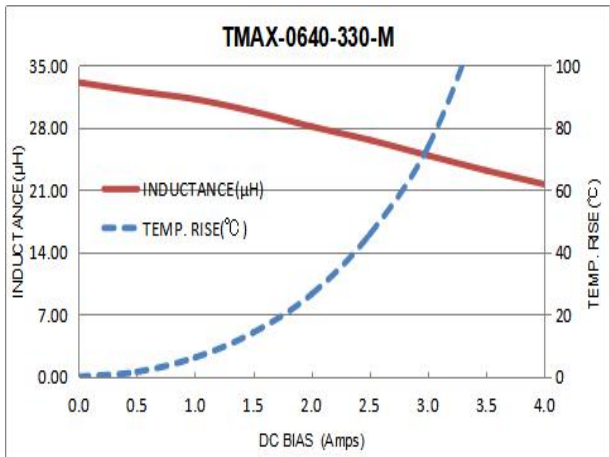
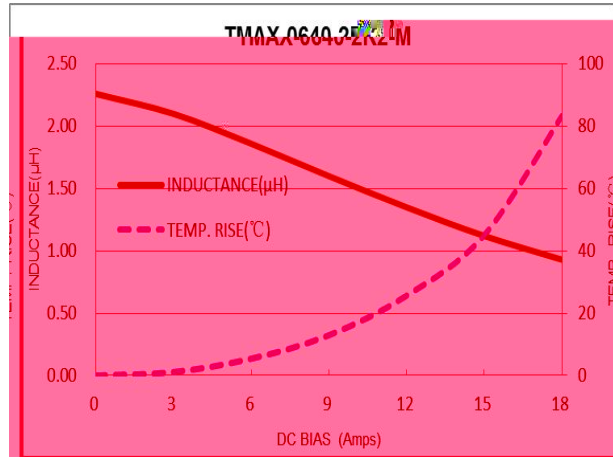
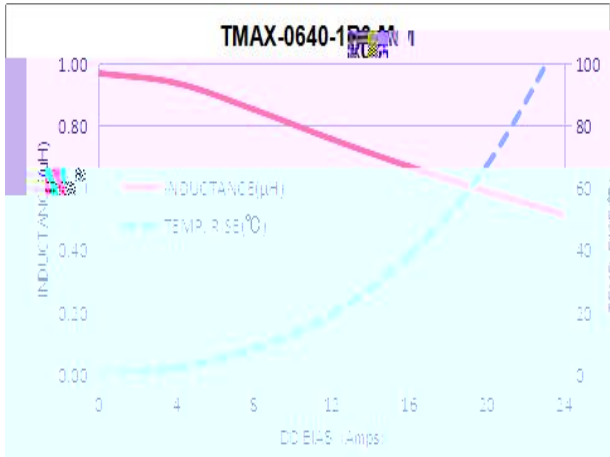

:

I

 $\pm$   
 $\pm$  °C  $\pm$  $\pm$

:

I		
	$\begin{matrix} \pm & \pm & \rightarrow \\ & & \rightarrow \pm \\ \pm & \rightarrow & \end{matrix}$	
	$\pm$	$\pm$
	$\pm$	
	$\pm$	
	$\pm$	

**D**

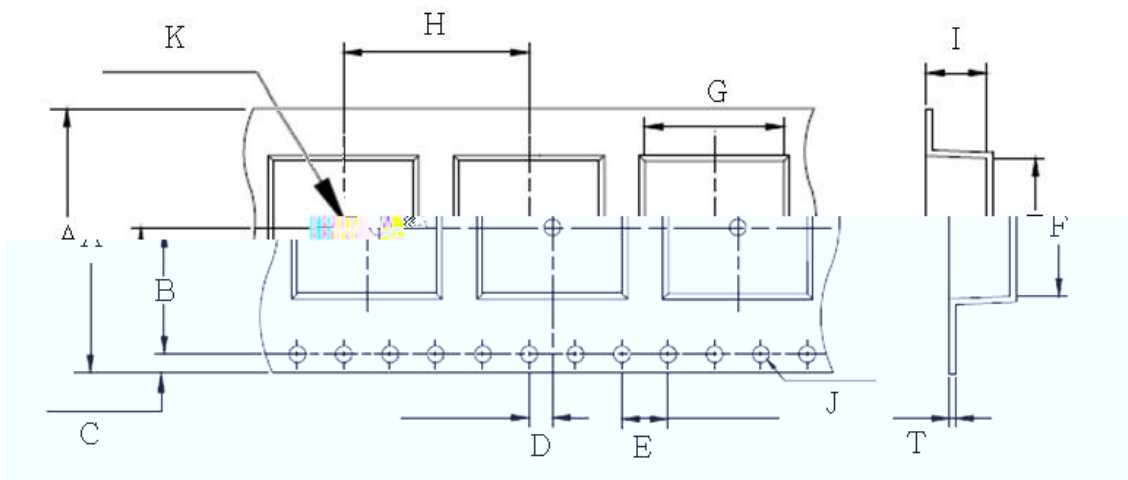

±	±	±	±	±	±
±	±	±	±	±	±

**D**

±	±	

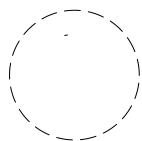

- 
- 

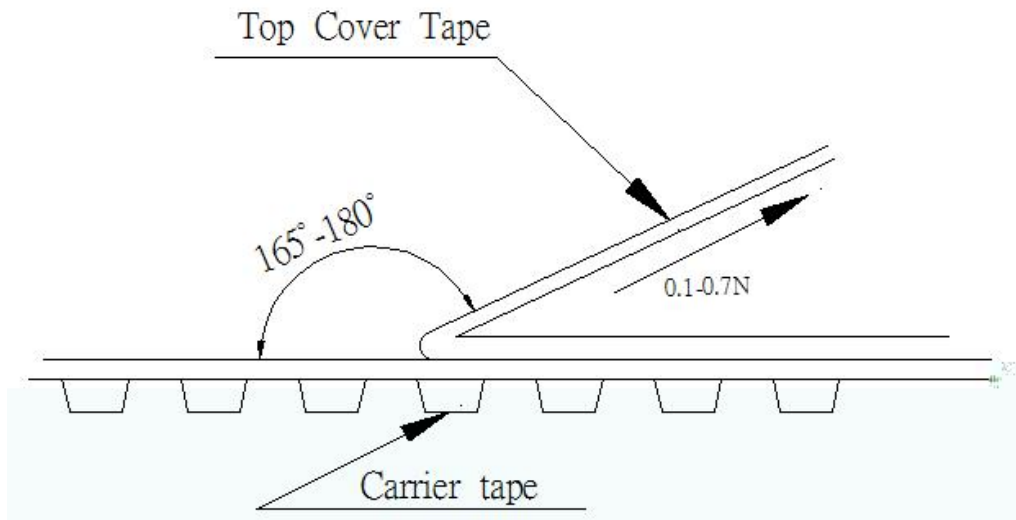





●

└

●

●

L

L

✓

✓

✓

✓

✓

✓

✓

✓

✓

✓

C

C

➤

➤

✓

✓

✓

✓

➤

➤ D

**C**

➤

➤

➤

➤

➤

➤

➤