

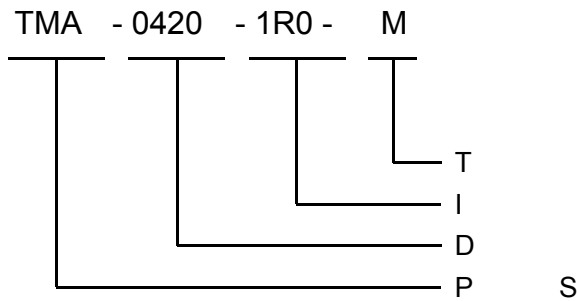

- L
- L DCR
- H
- H (I )
- R HS H F
- L EMI

- R 
- DC/DC
- T -
- G
- L PC
- SSD



M= 20%  
1R0=1.0 H

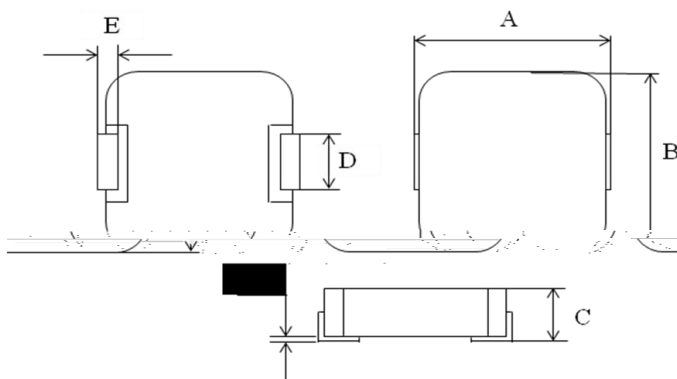

A	
B	
C	
D	
E	
F	

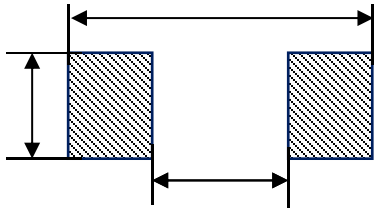

- T : 3-
- F : 1R0 1.0 H, R10 0.1 H.

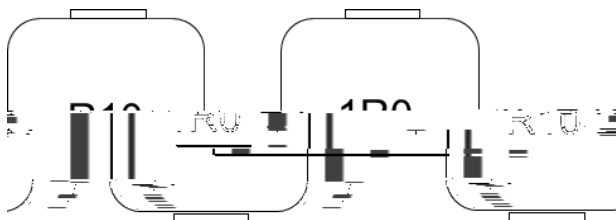

	L <sub>0</sub> (μH)	T	T .	M .	S	
					C	
					I (A .)	
					T .	T .
TMA -0420-R10-M	0.1	20%	3.1	4.0	25	12
TMA -0420-R22-M	0.22	20%	5.8	6.6	16	11
TMA -0420-R47-M	0.47	20%	12.5	14	9.5	7.5
TMA -0420-1R0-M	1.0	20%	20	26	7.0	5.0
TMA -0420-1R5-M	1.5	20%	38	46	6.0	5.0
TMA -0420-2R2-M	2.2	20%	45	58	5.0	4.5
TMA -0420-3R3-M	3.3	20%	76	87	4.0	3.2
TMA -0420-4R7-M	4.7	20%	92	105	3.0	3.0
TMA -0420-6R8-M	6.8	20%	125	150	2.8	2.5

1. A 23 3 C 45%RH 70%RH
2. T I : 3260B LCR M , 3265B B C S (100 H , 1 ), EUCOL-U25  
DC L
3. O - 55 C + 125 C ( + - )
4. I : DC (A)  $L_0$  30 %
5. I : DC (A) T 40 C.
6. T ( + ) 125 C  
. C , , P B  
. P
7. T

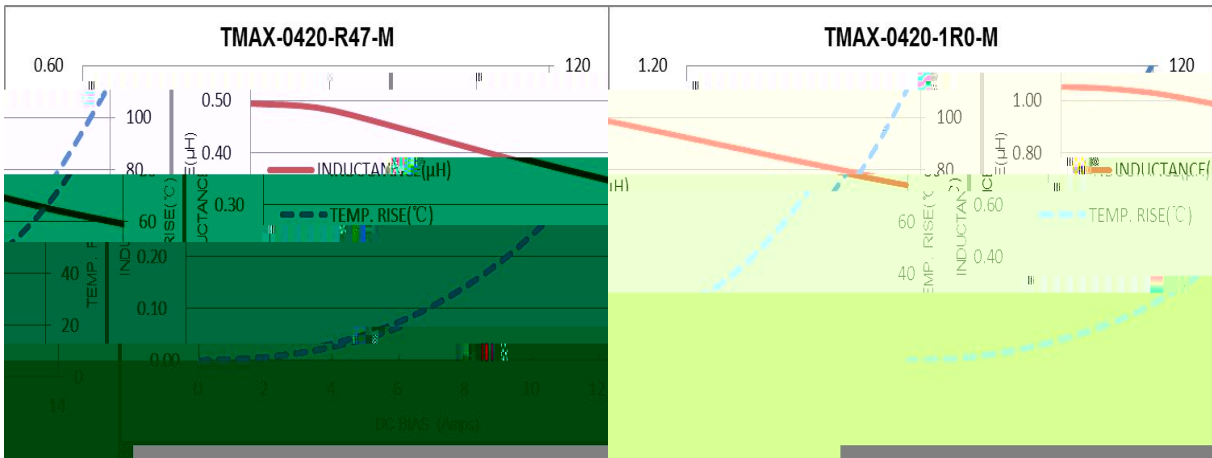
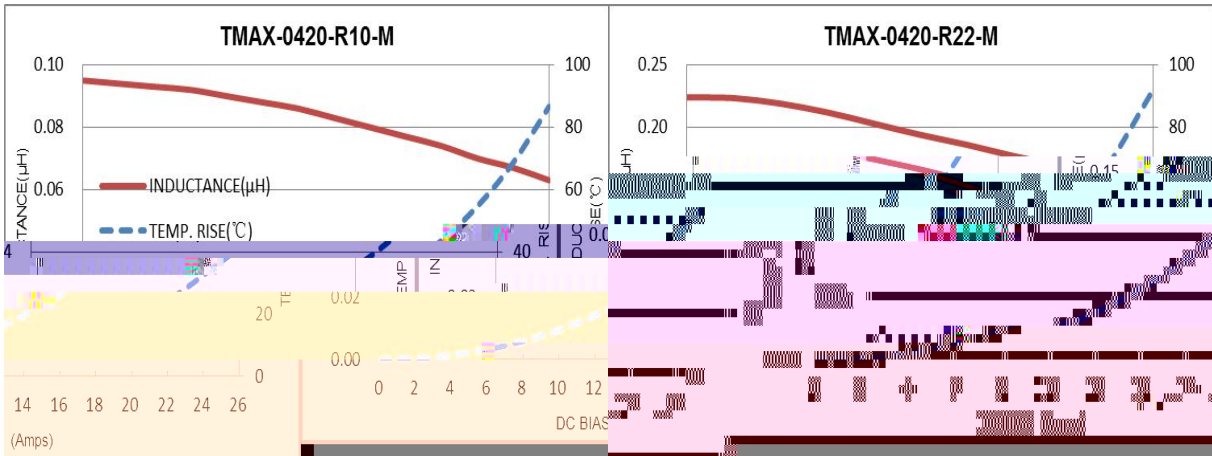

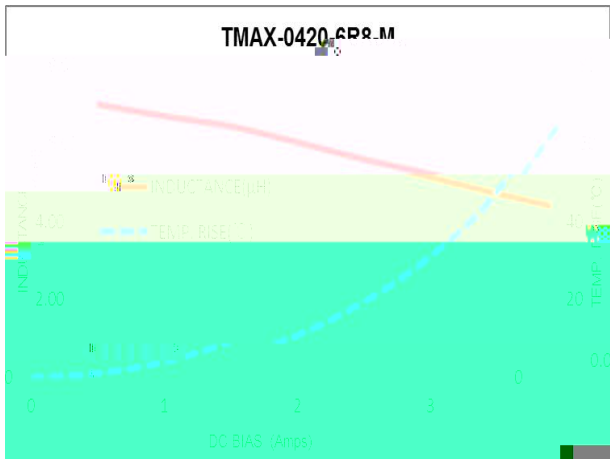
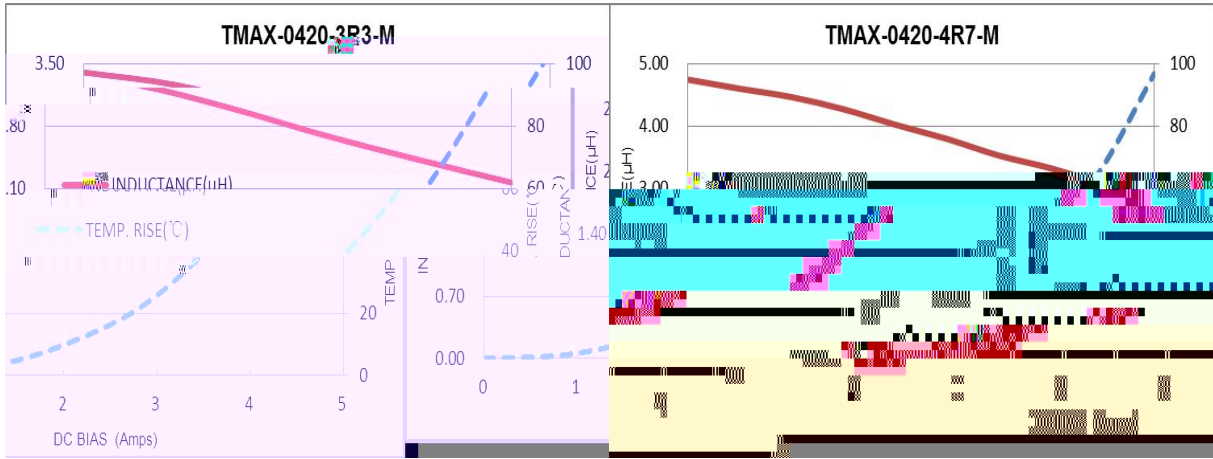
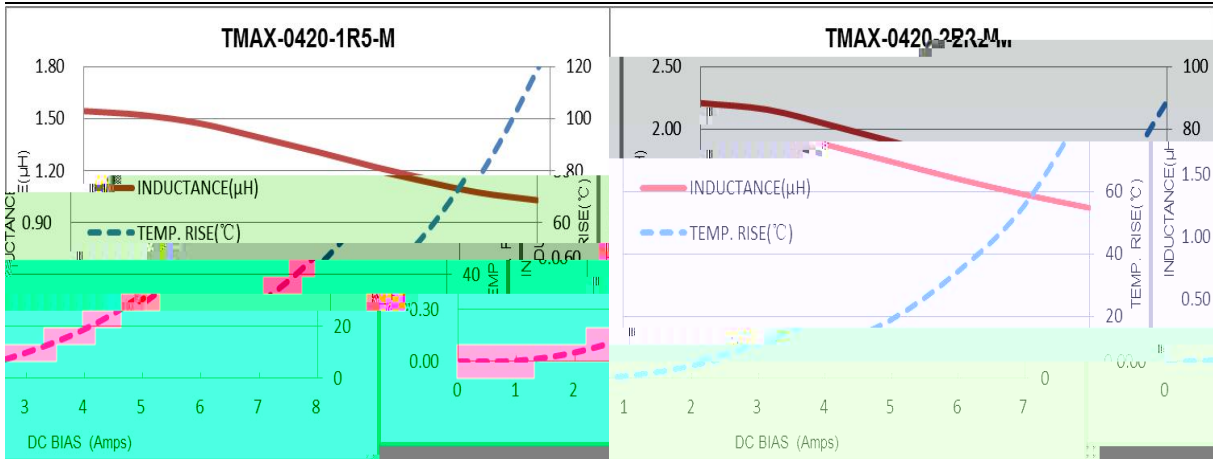

S	<p>S :</p> <p>1.P : <math>160 \pm 10</math> C 90</p> <p>2.R : <math>245 \pm 5</math> °C 2 ±</p> <p>0.5</p>	T 95%
	<p>1. (10H 55H 1 60</p> <p>2. : 3</p> <p>3.A : 1.5</p>	L/L <sub>0</sub> ± 5% N
S	<p>1.P : 100 G</p> <p>2.D : 11</p> <p>3.3</p> <p>3</p>	

T S	<p>1.R 100 :  <math>(-55 \pm 2 \text{ C}, 30 \pm 3)</math> → (R  , 5 ) → <math>(+125 \pm 2 \text{ C}, 30</math>  <math>\pm 3)</math> →  (R , 5 )  2.R : <math>48 + 4 / - 0</math></p>	
H T R	<p>1.E T : <math>85 \pm 2 \text{ C}</math>  2.A C : R  3.D : <math>1,000 + 4 / - 0</math></p>	L/L <sub>0</sub> ± 5%
H R	<p>1.E T : <math>60 \pm 2 \text{ C}</math>  2.R H : 90 95%  3.A C : R  4.D : <math>1,000 + 4 / - 0</math></p>	N
L T S	<p>1.S : <math>-55 \pm 2 \text{ C}</math>  <math>1,000 + 4 / - 0</math></p>	
H T S	<p>1.S : <math>+125 \pm 2 \text{ C}</math>  <math>1,000 + 4 / - 0</math></p>	

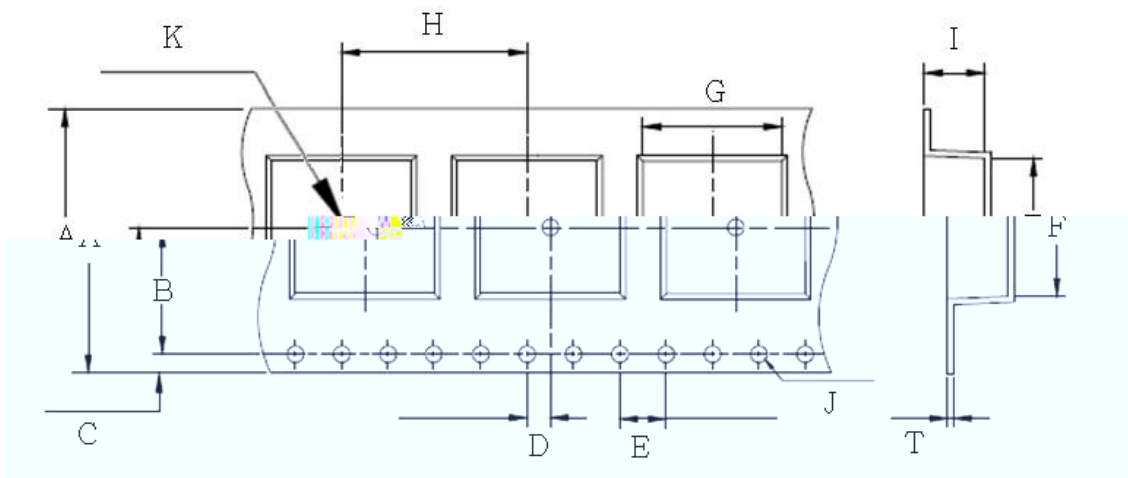

G	F	I	T	H	A
$4.5 \pm 0.1$	$4.8 \pm 0.1$	$2.5 \pm 0.15$	$0.35 \pm 0.05$	$8.0 \pm 0.1$	$12 \pm 0.2$
J	K	D	E	B	C
$1.5 \pm 0.1$	$1.5 \pm 0.1$	$2.0 \pm 0.1$	$4.0 \pm 0.1$	$5.5 \pm 0.1$	$1.75 \pm 0.1$

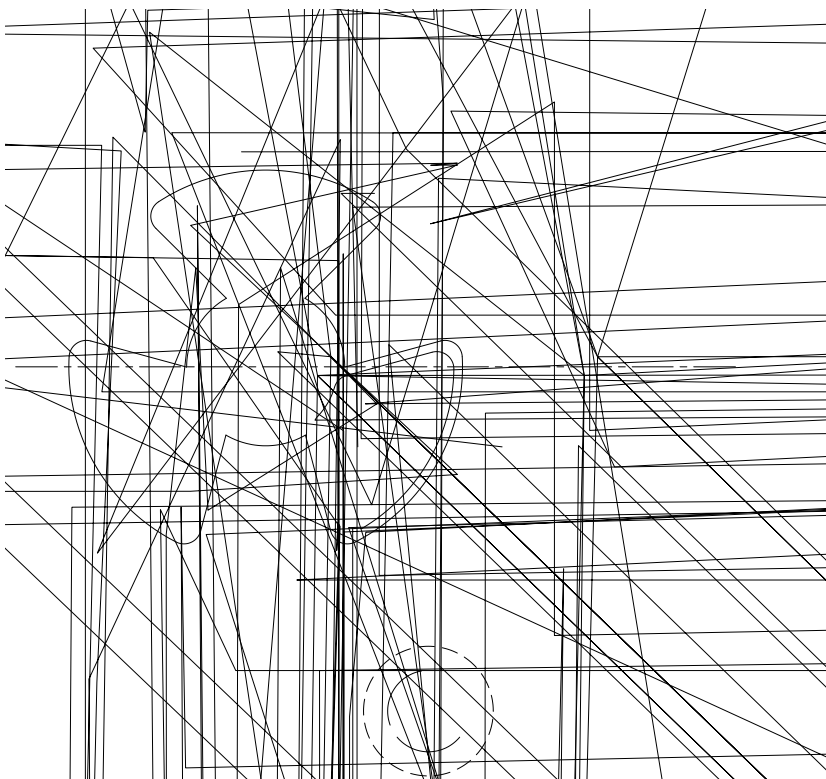

A	B	C
$12.5 \pm 0.2$	$2.0 \pm 0.2$	B



- T 300 / .
- T 0.1 0.7 N.

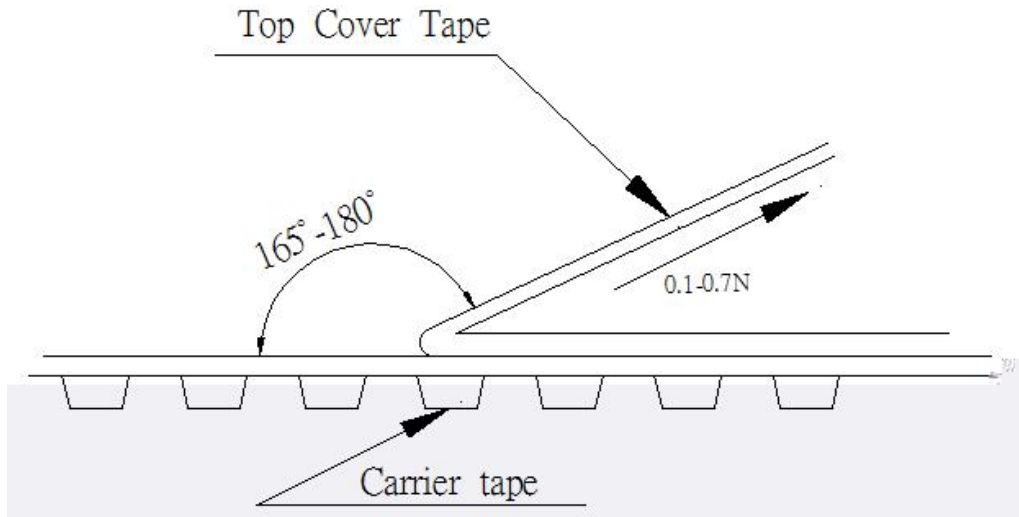

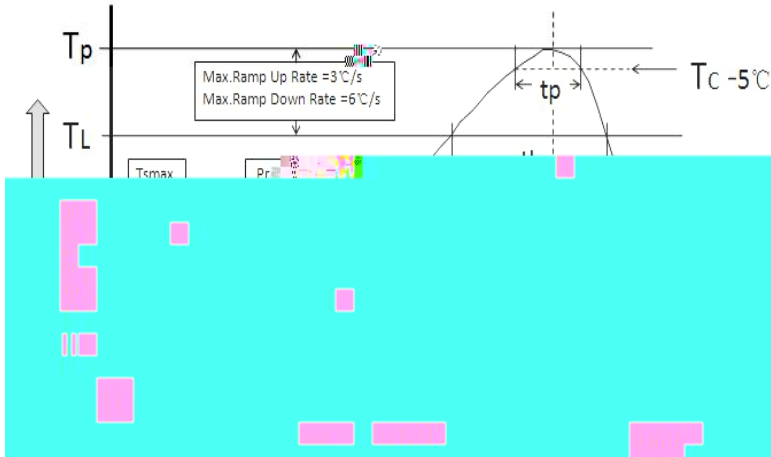

	<	≧
<2.5	235°C	220°C
≧2.5	220°C	220°C

	<		
<1.6	260°C	260°C	260°C
1.6-2.5	260°C	250°C	245°C
>2.5	250°C	245°C	245°C

P	S	T (T )	100°C	150°C
		T (T )	150°C	200°C
		T ( ):T T	60-120 S	60-120 S
A		TL T	3°C/S M .	3°C/S M .
L		(TL)	183°C	183°C
T		(L)	60-150 S	60-150 S
P		(T )*	T 1	T 2
T		( )** 5 °C (T )	20 **	30 **
A		T TL	6°C/S M .	6°C/S M .
T	25°C	P T	6 M M .	8 M M .

\*T (T )

\*\* T ( )

● 3,000 /

➤ P A C  
T

, - - , .T ,

/ .

➤ T R  
T

.I

➤ D S  
D

➤  
T

➤ P  
I

.P

➤ D  
P

➤ N  
T

( , , ) ..TDG H C .,L .

.I ,